

# International Luge Regulations

## Natural Track 2024

<b>§1</b>	<b>General Regulations.....</b>	<b>3</b>
<b>§2</b>	<b>Awarding of FIL Competitions .....</b>	<b>4</b>
	1. FIL Competitions .....	4
	2. Awarding FIL Championships and International Competitions .....	5
<b>§3</b>	<b>Disciplines, Rankings, Authorization, Judging .....</b>	<b>5</b>
	1. Disciplines .....	5
	2. Permission to Participate per National Federation .....	5
	3. Age Class Regulations .....	6
	4. Authorization to Participate in Training .....	7
	5. Ranking .....	7
<b>§4</b>	<b>Race Leadership, Jury, Technical Delegates, International Judges.....</b>	<b>8</b>
	1. Race Leadership.....	8
	2. Jury .....	9
	3. Technical Delegates .....	10
	4. Combined Responsibilities of the Technical Delegate, Jury and Race Director.....	10
	5. International Judges .....	10
	6. Assistant Judges.....	11
	7. Forerunner.....	11
	8. Incompatibility Rule .....	11
<b>§5</b>	<b>Sled and Equipment.....</b>	<b>11</b>
	1. General Regulations.....	11
	2. General Regulations Concerning Equipment .....	13
<b>§6</b>	<b>Medical Team.....</b>	<b>14</b>
	1. General Regulations.....	14
	2. Responsibilities.....	15
	3. Evacuation of Injured Persons.....	15
<b>§7</b>	<b>Advertising .....</b>	<b>15</b>
	1. Applicability, Measuring Procedure, Inspections.....	15
	2. Size of Advertising Surfaces .....	15
	3. Athlete .....	16
	4. Forbidden Advertising .....	17
<b>§8</b>	<b>Official Training .....</b>	<b>17</b>
	1. Training Courses.....	17
	2. General Regulations.....	17
	3. Authorization to Participate in Training.....	18
	4. Timekeeping .....	18
	5. Inspections .....	18
<b>§9</b>	<b>Race Preparation .....</b>	<b>19</b>
	1. Entries .....	19
	2. Entry Fees .....	19
	3. Draw .....	19
	4. Issuing Start Numbers.....	19
	5. Start Lists .....	20
<b>§10</b>	<b>Race and Results .....</b>	<b>20</b>
	1. Start .....	20
	1.1. General Regulations.....	20

1.2. Inspections	21
1.3. Command to Start: “Start is Clear”	22
1.4. False Start	22
1.5. Start Assistance	22
1.6. Classic World Cup Format with Team Competition	23
1.7. Championships	23
1.8. Parallel Competition	24
1.9. Eliminator Competition	25
<b>2. Sliding Rules and Procedures</b>	<b>26</b>
2.1. General Regulations	26
2.2. Classic World Cup Format with Team Competition	26
2.3. Championships	28
2.4. Parallel Competition	28
2.5. Eliminator Competition	30
<b>3. Finish Line</b>	<b>31</b>
3.1. General Rules	31
3.2. Parallel Competition	31
<b>4. Time Keeping and Identifying the Winner</b>	<b>31</b>
4.1. General Rules	31
4.2. Determining the Victor	32
4.3. Results with a Reduced Number of Competition Runs	33
<b>§11 Protests</b>	<b>34</b>
1. Reason for a Protest	34
2. Procedure	34
3. Settlement	34
<b>§12 Awarding the Title and Awards Ceremony</b>	<b>35</b>
1. Title for General Class and Junior World Championships	35
2. Title for Continental Championships	35
3. Awarding Titles when there are Fewer Competition Runs	35
4. Certificates	35
5. Medals	35
6. Pins	36
7. Gifts of Honor and Remembrance	36
8. Awards Ceremony and Conclusion of the Event	36
<b>§13 Concluding Regulations</b>	<b>37</b>
 <b>Supplements:</b>	
1. Regulation for Natural Luge Tracks	38
2. Rules for Instruction of International Judges	42
3. Regulation for Audiovisual-Media Rights	45
 <b>Drawings:</b>	
Drawing 1: General class luge, juniors and doubles	47
Drawing 2: Youth luge (non-offset runners)	48
Drawing 3: Steel geometry	49
Drawing 4: Start gates for team competition	50
Drawing 5: Start gates for parallel competition	51

## **§ 1 General Regulations**

- 1.1 The International Luge Regulations for Natural Track (IRO Natural Track) include the regulations for the proper staging of all competitions of natural track luge including championships and international FIL competitions. It is also valid for luge competitions during Olympic Winter Games (OWG).
- 1.2 The sanctioning body and event organizers as well as the participating nations, sport clubs, teams, athletes, judges and all assigned volunteers are obliged to adhere to the following regulations and use them during the staging of competitions on natural tracks during Olympic Winter Games, FIL Championships and international competitions, provided that there are no IOC regulations, FIL statutes or resolutions of FIL bodies contradicting these regulations.
- 1.3 Athletes registered by their National Federations (NFs) can participate in all FIL competitions if they have a valid e-licence. A FIL e-licence is required in the junior 1, junior 2 and general classes.
- 1.4 The event organizer authorized to stage FIL competitions is obligated to secure liability insurance for the entire duration of the competition in which the extent of the coverage is to be regulated through a written agreement. Any liability of the FIL will be explicitly excluded.
- 1.5 All NFs have the right to apply for the staging of FIL Championships and international competitions according to the IRO Natural Track regulations. With the application to host an event, the respective NF acknowledges the IRO regulations for Natural Track and all other FIL Regulations. Deviations from these regulations are possible only if the responsible FIL bodies according to the statutes explicitly approve these.
- 1.6 Athletes, FIL officials, National Federations, physicians, coaches, managers and other participants in the sport of luge are obligated to comply with the Anti-Doping Code of the FIL during and outside competition.
- 1.7 The word “athlete” used in the IRO Natural Track includes both, female and male competitors.
- 1.8 The sport year of the FIL starts on July 1<sup>st</sup> and ends on June 30<sup>th</sup> of the following year.
- 1.9 Violations against the regulations of the IRO Natural Track result in disqualifications and/or other sanctions, which are specified in the Law and Procedure Regulations.

## § 2 Awarding of FIL Competitions

### 1. FIL Competitions

#### 1.1 FIL Championships

World Championships (WCh)	in odd numbered years
Junior World Championships (JWC)	in even numbered years
U23 World and European Championships	“Race in Race” / at FIL Championships
Continental Championships <ul style="list-style-type: none"><li>• European Championship (ECh)</li><li>• American Pacific Championships (APCh)</li><li>• Asia Championships (ACh)</li></ul>	in even numbered years
North American Championships	annually
Continental Championships for juniors	in odd numbered years

The championships are numbered sequentially, including awarded championships that have been cancelled:

<b>25th World Championship</b>	<b>2025</b>
<b>38th Jr. European Championship</b>	<b>2025</b>
<b>15th Junior World Championship</b>	<b>2026</b>
<b>31st European Championship</b>	<b>2026</b>

#### 1.2 International Competitions

##### 1.2.1 World Cup (WC) — at least 5 races

World Cup races may be held in a classic format as parallel competitions or eliminator races. Double World Cups are possible in exceptional cases.

##### 1.2.1.1 The number of competitions, their location and the dates are proposed by the Natural Track Committee and approved by the Executive Board.

##### 1.2.1.2 The athletes who have been registered with the organizers by the National Federations may participate in all World Cups providing that the prescribed conditions have been observed (see §3).

##### 1.2.1.3 Subsidy

The FIL covers accommodation for each World Cup as per the current resolutions.

##### 1.2.2 Junior World Cup (JWC)

##### 1.2.2.1 The number of competitions, their location and the dates are proposed by the Natural Track Commission and approved by the Executive Board.

##### 1.2.2.2 The purpose of the Luge Junior World Cup is to promote up-and-coming talent in natural track luge.

##### 1.2.2.3 The athletes who have been registered with the organizers by the National Federations may participate in all Junior World Cups providing that the prescribed conditions have been observed (see §3).

##### 1.2.3 FIL Youth Games

##### 1.2.3.1 The athletes who have been registered with the organizers by the National Federations, regional federations and clubs, may participate in the FIL Youth Games providing that the prescribed conditions have been observed (see §3).

##### 1.2.3.2 The event is restricted to three days.

##### 1.2.3 Other international competitions

International competitions are competitions in which athletes from at least two National Federations participate.

## 2. Awarding FIL Championships and International Competitions

- 2.1 The Congress awards FIL championships a maximum of four years in advance. The championships are awarded in response to written requests on the part of the National Federations.  
The President of the FIL must receive the request eight weeks before the Congress.  
Two years before the championship, either the official confirmation of the track, or a positive report by the Chairman of the Natural Track Construction Commission must be submitted to the Executive Board.  
If one of the aforementioned requirements has not been met, the competition may be awarded to another event organizer.
- 2.2 The Executive Board is responsible for awarding the World Cups upon the request of the National Federations, or in consultation with them.
- 2.3 All other FIL competitions are also confirmed or awarded by the Executive Board.

## **§ 3 Disciplines, Rankings, Authorization, Judging**

### 1. Disciplines

The following disciplines participate in the championships and competitions:

- Women's singles
- Men's singles
- Doubles
- Team Competition

A team competition shall be held at championships (juniors and general class).

The organizer together with the Natural Track Sports Director shall determine whether the Team Competition is to be held prior to or following the individual competitions.

If they are held prior to the individual competitions, the athletes who did not participate in the Team Competition shall be allowed an additional training run.

### 2. Permission to Participate per National Federation

	Women's	Men's	Doubles
2.1 World Championships	4+1	4+1	3+1
2.2 Junior World Championships	4	4	3
2.3 Continental Championships	4	4	3
2.4 Continental Jun. Championships	4	4	3
2.5 World Cup	4	4	3

Continental Championships are held as a race within a race during the World Cup (Juniors as well as General Class). At a race-in-race event, when appointing athletes, teams must identify who shall compete in the World Cup and who shall compete in the championships.

Exception: In North American championships, the number of participants is unrestricted.

In General Class World Championships, the titleholders are also entitled to compete (+1); and with respect to the doubles, only the team that won the title is entitled to compete.

The U23 Championships will be held as a "Race in Race" with the FIL Championships (§ 2, 1.1).

- Athletes participating in the U23 Championships must comply with the following age requirements:

o Maximum age: year of the event - 23

o Minimum age: according to IRO § 3, No. 3.2

- The participating athletes must be registered for the FIL Championships within the scope of admission (§ 3, No. 4).

- Awarding of titles: men's/women's singles and doubles as well as team competition, if at least three (3) athletes/pairs of athletes have achieved a result in the respective discipline at the FIL Championships.

- The FIL Championships ranking will be used to determine the winners and placed athletes.

- A separate list of results will be compiled for the U23 classification.

2.6 In Continental Championships, all nations are entitled to compete; however, only those nations of the continent where the event is held may appear in the ranking. Separate lists of results therefore have to be prepared.

2.7 **Number of Participants in the Junior World Cup:**

The number of participants is not restricted.

Youth classes are not allowed to participate.

2.8 **Number of Participants in the FIL Youth Games:**

The number of participants is not restricted.

The following age groups are entitled to compete:

- Youth 1 Singles

- Youth 2 Singles

- Youth 3 Singles

- Youth 4 Singles

3. **Age Class Regulations**

3.1 FIL competitions are held for the following age groups:

- Youth 1

- Youth 2

- Youth 3

- Youth 4

- Juniors 1

- Juniors 2

- General class

3.2 Age groups for the individual age classes:

Youth 1 Minimum age Year of the event - 7

Youth 1 Maximum age Year of the event - 8

Youth 2 Minimum age Year of the event - 9

Youth 2 Maximum age Year of the event - 10

Youth 3 Minimum age Year of the event - 11

Youth 3 Maximum age Year of the event - 12

Youth 4 Minimum age Year of the event - 13

Youth 4 Maximum age Year of the event - 14

Juniors I Minimum age Year of the event - 15

Juniors I Maximum age Year of the event - 17

Juniors II Minimum age Year of the event - 18

Juniors II Maximum age Year of the event - 20

General class Minimum age Year of the event - 21

(minimum age and maximum age = age class)

For competitions that occur at the beginning of the season (July 1 - December 31), athletes are assigned to the class to which they would belong for competitions taking place after the following January 1.

- 3.3 For general class championships and international competitions, the athletes must at least be the minimum age (year of the event minus 15).

**4. Authorization to Participate in Training**

An athlete is permitted to train when:

- the athlete has not competed for another nation during the current sport year,
- a valid e-license has been presented,
- the rules governing age groups have been satisfied.

In addition to those cited under §3(2), for each nation, one additional athlete per individual discipline as well as an additional doubles team may train in championships. After the last training run, the team captain must notify the race organizer which athletes are to be omitted.

Each participant who is only competing in the doubles event is entitled to one training run as a single.

**5. Ranking**

**5.1 World Cup**

- 5.1.1 Fundamentally, 6 competitions or more are held per season. Double World Cups, parallel competitions and eliminator races are permitted.

The classic World Cup format will be contested in singles and doubles events in two competition runs.

- 5.1.2 The following points per competition shall be awarded for the results achieved in a World Cup:

Women's/Men's/Doubles:

1st place	100 pts.	15th place	26 pts.	29 <sup>th</sup> place	12 pts.
2nd place	85 pts.	16th place	25 pts.	30 <sup>th</sup> place	11 pts.
3rd place	70 pts.	17th place	24 pts.	31st place	10 pts.
4th place	60 pts.	18 <sup>th</sup> place	23 pts.	32 <sup>nd</sup> place	9 pts.
5th place	55 pts.	10 <sup>th</sup> place	22 pts.	33th place	8 pts.
6th place	50 pts.	20 <sup>th</sup> place	21 pts.	34 <sup>th</sup> place	7 pts.
7th place	46 pts.	21st place	20 pts.	35 <sup>th</sup> place	6 pts.
8th place	42 pts.	22nd place	19 pts.	36 <sup>th</sup> place	5 pts.
9th place	39 pts.	23rd place	18 pts.	37 <sup>th</sup> place	4 pts.
10th place	36 pts.	24 <sup>th</sup> place	17 pts.	38 <sup>th</sup> place	3 pts.
11th place	34 pts.	25 <sup>th</sup> place	16 pts.	39 <sup>th</sup> place	2 pts.
12th place	32 pts.	26 <sup>th</sup> place	15 pts.	40 <sup>th</sup> place	1 pt.
13th place	30 pts.	27 <sup>th</sup> place	14 pts.	41st place	and all others,
14th place	28 pts.	28 <sup>th</sup> place	13 pts.		1 pt. each

Whoever obtains the highest number of points is considered the winner of the World Cup. In the event of tied scores in the final ranking, the number of 1st places, 2nd places (etc.) shall determine the winner. If these are also identical, the athlete/doubles team with the best results in the final competition shall be used as the tie breaker.

- 5.1.3 For the national ranking, the points of all the athletes of a National Federation are totaled. After each World Cup, an intermediate result shall be calculated from the individual ranking and national ranking.

- 5.1.4 Each doubles team shall be ranked individually. If any doubles athlete competes with a new partner, this doubles team shall be re-ranked.

- 5.2 **Luge Junior World Cup:**
- 5.2.1 The classic Junior World Cup format is carried out in two competition runs in the singles competition and in one competition run in the doubles competition.
- 5.2.2 The point system for the Junior World Cup corresponds to that of the World Cup (see 5.1.2).
- 5.3 **Team Competition**
- 5.3.1 A team consists of two singles athletes, one woman and one man. Teams with athletes from different nations are not permitted.  
For each race, each nation may name different athletes to the team (see §10 Para. 1.6.3, Team starting procedure and Drawing 4).
- 5.3.2 Each nation is only permitted one team in each FIL competition.  
In World Championships, Continental Championships and World Cups, at least five nations must submit a team otherwise, the competition shall not be held.
- 5.3.3 In the World Cup overall ranking, the points from the Team Competition may only be included in the team ranking and national ranking; the points are not assigned to the individual athletes. For the overall World Cup victory, no separate points are added to the team ranking; points are, however, added to the national ranking from the team ranking.

## § 4 Race Leadership, Jury, Technical Delegates, International Judges

### 1. Race Leadership

The race leadership includes: The Race Director, Start Leader, Finish Leader and Chief of the Track.

#### 1.1 **Race Director**

- 1.1.1 The Race Director is responsible for staging the competition.
- 1.1.2 The Race Director declares that the track is clear for training and competitions when:
- the Chairman of the Technical Delegates has provided written confirmation,
  - all officials are in their positions and all technical equipment is in order after calibration or testing,
  - the medical services are present,
  - all communication equipment is available and functional,
  - all other provisions of the IRO have been satisfied.
- 1.1.3 If the jury or Technical Delegate(s) identify any problems which would impair proper staging of the event, the problems must be rectified by the Race Director.
- 1.1.4 In the event of accidents or failure of technical equipment, the Race Director must close the track.
- 1.1.5 The Race Director is entitled to send any athlete to the track physician for an assessment if they have reason to believe any athlete is injured or ill, if competing would pose a specific danger to the athlete's life or safety, or for any other reason. If the track physician confirms in writing that a specific danger to life or safety exists, the Race Director may refuse the athlete permission to start official training, and/or, from competition.
- 1.1.6 The Race Director must inform the Chairman of the Jury and the TD of any concerns.
- 1.1.7 In the event of any violations, the Race Director is responsible for making all necessary decisions.
- 1.1.8 If the appointed Race Director fails to implement the guidelines of the FIL and makes independent decisions that contravene the guidelines of the IRO or FIL, the Race Director may be relieved of his duty by responsible parties of the FIL in consultation with the jury.



If the appointed Race Director withdraws for any reason or must be replaced during a competition, the Finish Leader shall assume his duties until a new Race Director is appointed. The new Race Director is appointed by the event organizer in consultation with the jury.

1.1.9 The Team Captains Meeting is conducted by the Race Director, the Natural Track Sports Director, or a responsible party of the FIL.

1.1.10 The Race Director has the right in agreement with the TD, to exclude an athlete from training/competition who cannot meet the demands of the track.

## 1.2 **Start Leader**

1.2.1 The Start Leader is responsible for the start area. They are responsible for the inspection of the sled, the athletes' personal equipment, and supervise the start process.

1.2.2 Any violation of rules must be immediately reported to the Race Director.

1.2.3 During competition, if an athlete violates any provision within the IRO, their start shall not be permitted.

1.2.4 If a start is not permitted for reasons of safety during training (§ 5 Para. 1.4.7; 2.2; 2.3; 2.4 and 2.5), the athlete shall be recorded as "not started". "Not st." shall then appear in the score for this training run.

## 1.3 **Finish Leader**

1.3.1 The Finish Leader ensures that each athlete has passed through the finish correctly.

1.3.2 Any violation of rules must be immediately reported to the Race Director.

1.3.3. The Finish Leader completes the crash and finish log and submits it to the TD each day when all runs are finished.

## 1.4 **Chief of the Track**

1.4.1 The Chief of the Track is responsible for maintaining the track for training and competition.

1.4.2 They must immediately report any reasons for not using the track to the Race Director.

## 2. **Jury**

### 2.1 **Nomination and Composition**

2.1.1 During an FIL competition, the organizing National Federation may propose three candidates and three replacement candidates to the FIL Executive Board.

2.1.2 The proposed candidates must be members of a National Federation and possess an up-to-date International Judge's License.

2.1.3 In FIL championships, three members of the Jury are appointed by the Executive Board.

2.1.4 The Jury is composed of three members, and the chairperson bears the title of Chairperson. In FIL championships and World Cups, the Chairperson of the Jury is appointed by the Executive Board.

2.1.5 Only one member of the National Federation organizing the FIL competition may be a member of the Jury. In FIL championships and World Cups, the three Jury members must belong to different National Federations.

2.1.6 The appointments to the Jury are affirmed in writing by the National Federations, the organizer and appointed judges.

### 2.2 **Responsibilities**

2.2.1 The Jury is the highest authority of a competition. Within the framework of the IRO, the jury is charged with decision-making power for the duration of the competition.

2.2.2 Members of the Jury are not permitted to assume any additional function or position as a race official during a competition.

2.2.3 In addition to its supervisory responsibilities, the Jury shall decide on all written protests by a simple majority vote.

2.2.4 Each member of the Jury has access, without prior notification, to all technical equipment and facilities necessary for staging the competition.

- 2.2.5 All members of the Jury must be available at the beginning of training. The chairperson or at least one Jury member must be present at the TO briefing and at the first Team Captains Meeting.
- 2.2.6 If a member of the Jury is unable to participate, the remaining members in conjunction with the Sports Director shall appoint a replacement.

### **3. Technical Delegates**

#### **3.1 Nomination and Composition**

- 3.1.1 Technical Delegates are delegates of the FIL who offer professional advice the organizer of the competition and provide supervision and monitoring to ensure that the IRO is upheld.
- 3.1.2 In FIL World Championships, three Technical Delegates are appointed by the Executive Board. The chairperson bears the title of Chairperson.
- 3.1.3 The Executive Board appoints one Technical Delegate for all other FIL competitions.
- 3.1.4 A replacement TD may be nominated by the Vice President of Natural Track.

#### **3.2 Responsibilities**

- 3.2.1 Each TD has access, without prior notification, to all facilities involved in the competition.
- 3.2.2 During the days of training, the technical delegates, must grant the National Federations the opportunity to have their sleds and equipment examined.
- 3.2.3 During training and the days of the competition, the Technical Delegates are entitled to additionally inspect the sleds and equipment at any time.
- 3.2.4 Before each training and competition run, the Technical Delegates must inspect the track and facilities. The Technical Delegates (Chairman of the Technical Delegates) may only release the track to the Race Director if warranted by the inspection. The track release record is filled out in writing at the beginning of the day of training or competition.  
For general class FIL championships and World Cups, the officiating athletes' representative, or his representative, may be called upon by the Technical Delegate to help inspect the track before the first training session.  
The athletes' representative functions in an advisory capacity.
- 3.2.5 The Technical Delegates, in conjunction with the Race Director and Chief of the Track, must ensure that the track conditions remain essentially unchanged during a competition run.
- 3.2.6 The Technical Delegates must possess an International Judge's License.
- 3.2.7 The Chairman of the Technical Delegates must prepare the TD report in its entirety, have it signed by the FIL representative and distribute it according to the distribution lists.

### **4. Combined Responsibilities of the Technical Delegate, Jury and Race Director**

- 4.1 Before the first Team Captains Meeting, a TO (technical official) briefing must be held with the Technical Delegate (Chairman of the Technical Delegates), the Jury (at least one Jury member), the Race Director, Start Leader, Finish Leader, Chief of the Track and all the judges assigned by the local Organizing Committee.
- 4.2 Before training and competition runs, an operational plan must be prepared by the Race Director, Chairman of the Jury, and Chairman of the Technical Delegates. The Race Director must also hold an operational discussion with the track physician and paramedics.
- 4.3 In the event of decisions, protests, etc., the Jury may obtain the expert opinion of the Technical Delegate(s) or the Race Director.

### **5. International Judges**

- 5.1 For FIL competitions, the members of the Jury, Technical Delegates, Race Director, Start Leader, Finish Leader and the judges who make control measurements must have an international judge's license for the FIL.

Judges who only check temperatures and weights are not required to possess an international judge's license. For this activity, an "Assistant Judge" may also be used.

- 5.2 The National Federations are obligated to train judges who wish to acquire the international judge license.
- 5.3 National Federations which have no internationally approved judges to carry out FIL competitions must request international judges from the FIL for these competitions. According to the FIL travel cost reimbursement plan, compensation is to be paid by the NF staging the competition.

**6. Assistant Judges**

Individuals proposed by the event organizer may be trained to be an assistant judge. Training is provided in a briefing by the Technical Delegate or by judges authorized by the Technical Delegate. Candidates may be rejected at any time. The assistant judge may only be assigned to measure the temperature of the steels and weigh the sled. The license is only valid for the race for which the briefing was held.

**7. Forerunner**

Forerunners must present a regulation sled/equipment that complies with international or national standard, as well as a national or international sports license or a confirmation from their NF confirming that all criteria have been met. They may not be listed as a participant in the race, with the exception of athletes who have already been eliminated.

**8. Incompatibility Rule**

Officials and judges are forbidden to participate as athletes in the competition they are officiating at.

<b>§ 5 Sled and Equipment</b>
-------------------------------

**1. General Regulations** (see drawings no. 1+2, Page 47+48)

**1.1 Sled**

The sled must have a pair of single runners.

The primary components of the sled are:

- 2 runners
- Seat
- 2 "steels"
  - The steels may not be divided crosswise nor be flexible. The outside edges of the steels must be rounded.
- 2 undivided bridges
  - Only metal bridges are allowed.
- 2 hand guards "wings"
- 1 steering rein

Parts that are securely connected (immovable due to welding, bolting, etc.) are considered undivided. This holds true within the area of measurement E (300 mm).

The thickness of the bridge may never exceed 15 mm within measurement E; this is limited to 20 mm for doubles. See drawings 1+2, p. 47 + 48 (measurement I)

Bridges that are securely connected (immovable) may be angled.

Weld seams at the joints are permissible.

The connection from runner to runner must be one continuous piece between the attachment points to the runners.

All parts of the sled must be made accessible to the Technical Delegates and/or jury members and must be accessible to checking without technical difficulty.

## 1.2 **Steering**

Steering must result from the interaction of the above-mentioned primary components of the sled and may be assisted by stabilizer bars and reins.

On a doubles sled, steering may be assisted by foot supports for the back athlete.

Foot supports must be fastened to the upper edge of the runner and may not extend beyond the outer edge of the steel or above the height of the forward bridge middle section.

Mechanical braking devices are forbidden.

## 1.3 **Weight of the Sled**

Youth male and female	12,0 kg
Juniors male and female	14,5 kg
Women's and men's	14,5 kg
Doubles	20,0 kg

The weights stated above are maximum weights and include all attached accessories.

## 1.4 **Sled dimensions** (see drawings no. 1+2)

### 1.4.1 Measurement of the gauge at the inner edges of the running surfaces:

maximum 450 mm

maximum 400 mm for youth sled - measurement F

### 1.4.2 Inner spacing of the runners between the two bridges:

minimum 300 mm - measurement E

minimum 250 mm for youth sled - measurement E

### 1.4.3 Width of the sled including handles and hand guards:

maximum 600 mm - measurement H

### 1.4.4 Height of the sled from the highest point of the construction to the bottom edge of the sled:

maximum 250 mm - measurement D

### 1.4.5 The middle section of the forward bridge (pin) may not extend over the structure measurement C

### 1.4.6 Open angle of the steels:

maximum 45 degrees for singles

maximum 40 degrees for doubles

maximum 35 degrees for youth sled (steel steels are only permitted for youth I and II) - measurement A

The open angle/inclination of the steels must at no point exceed these angles over the entire length of the steel.

The front and back bridges of the youth sleds must be inserted into the runners within 50 mm (measurement K) from above.

Runner width: maximum 50 mm - measurement K

Runner height: maximum 65 mm - measurement L

A reinforced execution with sockets is permitted. This must be designed so that at least half of the bridge is inserted inside the runner (measurement K).

### 1.4.7 Hand guards for all classes on the outside of the runners from the middle of the front bridge to the middle of the rear bridge - measurement J

at least 50 mm from the inside of the running surfaces horizontally to the outside - measurement G

maximum 75 mm from the guard strip edge vertically to the ground - measurement B

### 1.4.8 The drawings are only for illustrating the regulation dimensions of equipment. They do not affect construction.

- 1.5 Pod**  
The pod may not extend beyond the front bridge by more than 200 mm.
- 1.6 Steels** (see drawing no.3, Page 49)  
1.6.1 Steels: width minimum 23 mm, the maximum 31 mm - measurement A  
The running surface must not be concave (hollow ground).  
The running surface of steels with a plastic insert is within the inner steel portion of the steel.  
The running surface of steel steels is at least 3 mm wide measured from the inside edge of the steel.
- 1.6.2 Inside cutting angle of the steel, minimum 53° - measurement  $\alpha$
- 1.6.3 Measuring depth of the side edge: minimum 3 mm - measurement B  
The measured surface may not be concave (hollow ground) in this area.
- 1.6.4 Height of the burr: maximum 0.09 mm, measurement C (measured perpendicular to the running surface)
- 1.6.5 At a maximum, the burr may extend the length of the side edge - sketch D
- 1.6.6 The contact surface on the steel edge of the steel must be flat so that the measuring equipment may be properly applied.  
The measuring device for measuring the burr must have a scale gradation of 0.01 mm.
- 1.6.7 To precisely calibrate the dial gauge to zero, a polished official FIL gauge piece made of steel must be used. The contact surface of the reference piece must be at least as large as the contact surface of the measuring device.
- 1.7 **Measured Areas**  
The above specified measurements and dimensions must be maintained over the entire sled, except for the gauge measurement 400/450 mm. This measurement is measured from the middle of the front bridge to the middle of the back bridge (see paragraph 1.4.1).
- 2. General Regulations Concerning Equipment**
- 2.1 General Information**
- 2.1.1 All items of racing clothing, including helmets and racing shoes, must correspond or be adapted to the athlete's body.  
Additional changes are not permitted. Goggles are allowed. Aerodynamic connections between the head and upper body are not permitted.  
Each athlete must participate in competitions (including training) with regulation race clothing.
- 2.1.2 Additional body protection (protective pads) must conform to the shape of the athlete's body.
- 2.1.3. The use of ankle braces recommended and approved by the FIL is obligatory for the following age groups (see 2.5).  
  
Those born in 1996 and younger
- 2.2 Gloves**  
The wearing of gloves is mandatory. The effective length of the spikes of the gloves and the arrangement of the spikes is not regulated.
- 2.3 Helmets**  
All athletes must wear a helmet. Each athlete who takes part in an FIL competition must wear a helmet that meets the safety provisions of his/her national federation. The outer ear must be covered by the uniform helmet material. Helmets constructed to let in sound are allowed. Any other structures are not permitted. See the illustration of the helmet type.



Example: Helmet with openings for hearing

2.4 **Racing Shoes**

The booties must be ankle-high.

The booties must have spikes that are attached to a plate or securely affixed to the sole of the shoe. The length and arrangement of the spikes is not regulated.

2.5 **Ankle Braces**

All athletes in an age group that is entitled to compete who were born in 1996 or later must wear ankle braces designed like an OSG ankle orthotic (with reinforcing bars) or racing shoes with integrated ankle protection manufactured by Stadler for all FIL events (Junior World Cup, General World Cup and FIL championships).

The control takes place at the start as part of the safety equipment, i.e. that no starting permit for this run can be granted if is not used.

The Technical Delegates or an individual authorized by them are authorized to perform the inspection.

2.6 **Race Suit**

Only textile fabrics with an exterior surface which must not be plasticized or otherwise sealed may be used for race suits. Additional race clothing (i.e. Velcro pants doubles) have to be adapted to the colors of the suits.

## § 6 **Medical Team**

1. **General Regulations**

During the official training and race runs of any FIL competition, the following must be available:

A race physician with knowledge of emergency care must be at the track.

A minimum of one ambulance with one paramedic/ambulance officer. The ambulance must also be equipped with appropriate resuscitation equipment and be suitable/capable of accessing all roads around and along the track. The ambulance crew must be placed in such a way that, in accordance with the local conditions, immediate pick up of any ill or injured person is possible from all areas of the track.

Should the race physician and/or the ambulance be medically required, the race and official training must be interrupted until their services according to the above-mentioned regulations are again guaranteed.

## 2. **Responsibilities**

The race physician and/or the ambulance crew are responsible for the primary care of injuries or illnesses of the athletes. The race doctor must certify in writing to the Race Director when there is a specific risk to life or health by the participation of an athlete as a result of an injury or illness or for any other medical reason (§ 4 Section 1.1.5).

Every time a medical intervention is needed, the race physician and the technical delegates have to write an accident report (i.e. form no. 9a/9b) and attach it to the technical report.

## 3. **Evacuation of Injured Persons**

The event organizers must guarantee that injured persons can be transported away from any point along the entire length of the track without obstruction or difficulties.

# § 7 Advertising

## 1. **Applicability, Measuring Procedure, Inspections**

### 1.1 **Applicability**

All these regulations are in force during FIL competitions, as well as for media and PR activities within the scope of FIL competitions and apply for athletes and officials. The respective NF is responsible for the compliance with the advertising regulations (§7).

### 1.2 **Measuring Procedure**

A rectangle is used to calculate the size of the advertising surface. The width (A) and height (B) of the trademark determine the sides of the rectangle.



If the trademark is integrated within an area of different color, the total area of the different color is to be measured.

The markings on the clothing will be measured when the clothing is not worn.

### 1.3 **Inspections of the Advertising Surfaces**

At FIL competitions the Technical Delegates are authorized to initiate inspections of the advertising surfaces at any time.

In case of violations of the advertising rules a disqualification may be issued by the race director.

## 2. **Size of Advertising Surfaces**

### 2.1 **Race Clothing and other Clothing worn at the Field of Play**

Articles of clothing may carry manufacturers' identifications and/or trademarks of other sponsors.

The total surface area of all trademarks on the clothing (except head coverings, gloves, and shoes) of one person shall not exceed 600 sq cm.

The complete surface can be divided into 11 parts at the most.  
The complete surface of a single part may not exceed 200 sq cm.  
The trademarks of the same sponsor may not appear one above the other or one beside the other. The NFs may decide the placing of the trademarks.

## 2.2 **Safety Helmets**

Athletes' safety helmets may display two (2) trademarks of the manufacturer with a maximum size of 15 sq cm, one each side, placed over the ears.

The advertising surface on the front of helmets may only be used by the FIL (70 sq cm). If the FIL grants this advertising space to the national federations, the industry exclusivity of the FIL main sponsors must be observed.

A national emblem (max. 30 sq cm) and the name of the athlete (maximum twice and the height of the lettering is limited to a maximum of 15 mm) are permitted on the helmet when they are not obstructing the official FIL advertising.

## 2.3 **Goggles**

Goggle straps shall correspond to the commercially available design.

The width of a goggle's strap shall not measure more than 4 cm.

In the case of double straps, only one strap may carry the trademark.

## 2.4 **Caps, Headbands and other Headgear**

Caps, headbands and other headgear may each have a maximum of three (3) trademarks of the manufacturer and/or other sponsors, with a maximum total surface of 100 sq cm.

## 2.5 **Start Numbers**

Advertising labels on start number bibs are permitted. These may only be used by the FIL.

In doubles competition, both athletes shall wear start numbers.

During FIL Championships of the general class and during WCs, the start number bibs provided by the FIL sponsor must be worn during the official training as well.

## 2.6 **Racing Shoes**

Racing shoes may only show one manufacturer's trademark on each shoe.

The size and quantity of the manufacturer's logo on the shoe must not exceed the size and quantity of a product which is publicly available.

## 2.7 **Gloves**

Gloves may only show one manufacturer's trademark on each glove, size 15 sq cm.

The trademark can be divided into two parts.

## 2.8 **Sled**

In addition to the manufacturer's trademark, a maximum of (six) 6 commercial trademarks may be displayed on the entire sled, of which a maximum of (two) 2 trademarks may be displayed on the bottom of the seat mat.

The size of the advertising surface on the bottom of the seat mat may not exceed 1000 sq cm.

## 3. **Athlete**

Advertising with athletes is only allowed with the permission of the responsible NF.

The name, title and picture from the athletes can only be used once for each advertisement.



#### 4 **Forbidden Advertising**

Provided there are no stricter national laws, following advertisement is prohibited:

1. on the athlete and sled: advertising for tobacco, illegal drugs or alcohol. Exception: advertising for non-alcoholic beer and, regarding athletes of age (18), advertising for products with an alcoholic percentage of less than 10 %.
2. at the sports venue and on bibs: advertising for tobacco, illegal drugs or products with an alcoholic percentage of more than 10 %. The FIL Executive Board can allow an exception of this prohibition following a request from the event organizer or the venue operator.
3. advertising conveying religious, racial or any other discrimination.

### **§ 8 Official Training**

#### 1. **Training Courses**

- 1.1 Subject to track and weather conditions and prior to the staging of the event, the NF that is hosting the FIL Championships must provide national or international training days to all NFs on the track where the competition is to be held.
- 1.2 The coordination and staging of the training days is strictly a matter of the NF. The terms of these training days are to be set up in the contract with the NF.

#### 2. **General Regulations**

##### 2.1 **Official Training Runs**

- 2.1.1 At least one forerunner must always be available at the start for each training run. The forerunner must not use the track as an after-runner at the end of any training run.

	Singles	Doubles
FIL championships	at least 2	at least 2
FIL junior championships	at least 2	1
World Cups	at least 1	at least 1
Junior World Cups	at least 1	1
Other FIL competitions	at least 1	at least 1
Other FIL junior competitions	at least 1	1

- 2.1.2 The start order for the training runs will be carried out as a nation training. The nation with the lowest number of World Cup points starts first. Within the nation the athletes start in each discipline according to start number, beginning with the women. All participants, who start only in doubles, may complete a training run as a singles and start before the other men.
- 2.1.3 Each athlete must participate in at least one training run in singles or one training run in doubles. An athlete may participate in the qualification (World Cup, Parallel and Eliminator) and competition runs in championships even if he/she does not complete the training run on the full length of the course.

- 2.1.4 Reduced number of training runs:  
If conditions prevail which make scheduled training impossible (such as warm wind, snowfall, etc.), the Race Director, in agreement with the Chief of the Track, and the chairperson of the TDs may interrupt training and set up a new training time. In such a case, the Race Director shall determine the number of training runs to be completed following the confirmation of the chairperson of the TDs.
- 2.1.5 A separate date is to be set for training for doubles.
- 2.1.6 During the competition, all unauthorized training on the track other than during the designated training times is forbidden.
- 2.1.7 The track is to be closed to all training activities 2 calendar days prior to the time specified in the competition invitation for the beginning of training. Exceptions are permissible given the approval of the track operator, Technical Delegate and Sports Director.
- 2.1.8 In substantiated cases and with approval of the jury, the Race Director may allow athletes who have arrived late due to no fault of their own to complete the minimum number of training runs.

**3. Authorization to participate in training**

- 3.1. Classic World Cup format:  
Authorized to participate: Men's: 6  
Women's: 6  
Doubles: 4
- 3.2. Championships:  
In addition to those athletes cited under §3(2), one additional athlete per individual discipline as well as an additional doubles team may participate in training. See 2.1.2
- 3.3. Parallel competition:  
Authorization to participate like in the classic World Cup format
- 3.4. Eliminator races:  
Authorization to participate like in the classic World Cup format

**4. Timekeeping**

- 4.1 Paper copies of the run times are to be supplied and posted and must include at least one start time, two intermediate times and one final time.  
See the timekeeping manual for races on shorter tracks (such as parallel and eliminator races).
- 4.2 Electronic timekeeping must be used for all training runs. Official training run times must be officially announced.
- 4.3 Both team officials and athletes are forbidden from accessing the official timing systems.
- 4.4 Unofficial timing systems are only permitted during training and may only be set up in coordination with the Race Director and the chairperson of the TDs (setup must be a minimum of 20 meters in front of or behind any official timing systems equipment).

**5. Inspections**

Inspections at the start are also mandatory during training and must be performed on all equipment.  
All required measuring equipment and related personnel must be available for measuring as of the first training run.

**1. Entries**

Athletes are to be entered in accordance with the deadlines and procedures in the invitation. The naming of athletes for FIL championships and World Cups (General Class and Junior's) are to be provided solely by the National Federations.

**2. Entry Fees**

- 2.1 Entry fees for all athletes are to be paid to the organizer who shall in turn issue a receipt during distribution of the start numbers.  
For all FIL competitions, the amount of the entry fee for each athlete in each discipline shall be determined in euros by the FIL Executive Board.  
The entry fees remain the property of the organizer even when a NF withdraws the entry of one or more athletes.

**3. Draw**

- 3.1 The time and location of the draw shall be described in the invitation to the competition.
- 3.2 The Team Captain's Meeting with the draw is run by the Race Director, the Natural Track Sports Director, or the FIL representative.
- 3.3 During the draw, the Chairperson of the Jury must be present.
- 3.4 In the Team Captains Meeting with the draw, the minutes must be recorded and signed by the Race Director and the Chairperson of the Jury.
- 3.5 During FIL competitions, each athlete must wear a bib for start numbers. The start number must be visible on the chest and on the back. Start number bibs must be elastic and adhere closely to the upper body.  
They must be worn without alteration. Taping of the start numbers at the bottom edge is only allowed to a maximum width of 5 cm, and it may not cover any printing.  
During the awards ceremony (flowers ceremony), the three first place winners must visibly wear their start number bibs.
- 3.6 The starting order of the athletes for the competition is drawn for each discipline during the first Team Captain's Meeting.  
The exchange of start numbers is not permitted.
- 3.7 The draw shall be done only once before the beginning of training and shall remain the same for all training and competition runs. Exception: Eliminator races (new start numbers are drawn following qualification).  
A computer is used for the draw.
- 3.8 For the doubles, the names of the team members must be known before the draw. The registration of names for the doubles competition is binding.

**4. Issuing Start Numbers**

- 4.1 World Cup in the Classic format:  
The start numbers are awarded based on the placement in the last World Cup ranking (lowest number of points = lowest start number). A draw shall be held for athletes who do not appear in the World Cup ranking (0 points) or who have the same number of points.

The awarding of the start numbers during the 1st World Cup of the new season corresponds to the final ranking of the World Cup of the previous season.

4.2 **Championships:**

The athletes are placed in three groups according to their overall world cup rankings: athletes ranked 1-7 form one group, athletes ranked 8-14 form another group and all the remaining athletes form the third group. Within these groups the bib numbers shall be drawn randomly by computer.

In case of tied positions the athletes will be placed in the better group. In case of tied positions in the first group the group might consist of more than 7 athletes. In this case the second group will contain less athletes and will nevertheless end at the 14th ranked athlete.

In the first run the group with “the rest of the athletes” will start first, followed by the second group. The group with the best athletes starts at the end, all in the order of the drawn numbers.

Starting order in the second or third run is the reversed ranking of the previous run.

This applies only to the senior class. For juniors, the starting order for the first run will be drawn independently of the Junior World Cup points. The second run is done in reverse order.

4.3 **World Cup parallel competition:**

The draw is the same as for the Classic competition; see 4.1.

4.4 **World Cup eliminator competition:**

4.4.1 **WC eliminator race as single event:**

The drawing of lots for training and qualification is carried out as described in section 4.1. For the elimination rounds, after the qualification, the starting numbers will be allocated according to the ranking in the qualification: 1st place = 1, 2nd place = 2, etc. The best 26 women, 26 men, and 16 doubles participate.

4.4.2 **WC eliminator race as double World Cup in combination with classic format:**

There are no training and qualification runs, the best 26 women, 26 men, and 16 doubles participate according to the ranking of the overall World Cup points. If an athlete from the 26/26/16 cannot start, the next athlete, i.e. the 17, 18 etc. or 27, 28 etc. will move up.

Every athlete who starts in a eliminator race must have participated in at least one training run in classic format. If an athlete participates only in the eliminator race and not in the classic World Cup, he/she must be granted a start in at least one training run of the classic World Cup as an additional starter after being named.

**5. Start Lists**

The start list must be announced publicly and displayed at the start and finish. Sufficient copies of the start list must be made available to each team captain.

**§ 10 Race and Results**

**1. Start**

**1.1. General Regulations**

- 1.1.1 **Start order**  
In competitions that are held in 2 runs, the second run will start from the last to the best place in all disciplines. After the end of the first run, an interim results list is to be prepared and published at the start and finish.  
For competitions which are carried out in 3 runs, the start order in the individual disciplines as follows:  
1st run: 1 to last start number  
2nd run: Last placed to best placed after 1st run  
3rd run: last placed to best place after 2nd run, only the best 26 men, and 26 women are eligible to start.  
After completion of every run, an intermediate result list is to be prepared and published at the start and finish.
- 1.1.2 **Start rules**  
In all disciplines it is mandatory to start from a ramp.  
The start time and start order must be visible for the athletes at the start and finish.  
The athletes are responsible to inform themselves in time.  
During the FIL championships, Worldcups and international competitions, one to three fore-runners need to start per run.  
After a start disruption of a minimum 5 minutes, a forerunner has to start first. Then the race can continue.  
No fore-runner is allowed to use the track as after-runner at the end of each run.
- 1.1.3. **Call to start**  
The start of every run has to be announced through the track's loudspeakers 15 minutes, 10 minutes and 5 minutes before the first start.  
The call to start with the examination of the sled in the start area must be announced through the start leader or any other assigned person.  
The athlete must be in the start room within two minutes after the call to start.
- 1.1.4. **Start area**  
Smoking and alcohol are forbidden within the entire start area (in the start room including a surrounding radius of at least 20 m). Cell phones and radios may not be used in the start room, except for the official judges' radio communication.
- 1.1.5 **Start room**  
Aside from the start leader, the judges/assistant judges, the jury, and the TD, only the athlete starting next and his/her assistants are allowed in the start room.
- 1.2. **Inspections**
- 1.2.1. Inspections at the start:
- Weight check of the sled
  - Temperature check of the steels
  - Dimensions of the sled
  - Fixation of start number
  - Presence of safety equipment (including hand protectors, helmets, brake shoes and ankle braces (born 1996 or younger))
- Any violations of the control measurements at the start must be recorded in a log. After the official control measurement, the sled may not be removed from the start area (unless the start is interrupted).  
The weight of the sled is checked in the start area with a calibrated scale before each run.  
A calibrated weight of at least 1 kg must be available at the start.  
The scale must reflect incremental units of 100 g.
- No more than two "controlled" sleds may be in the start area.

In parallel and eliminator races, the checking of the sled at the start may be omitted as of the quarter finals, or the round including the last 10. However, safety equipment must still be checked.

#### 1.2.2 Temperature of the steels

Two calibrated pyrometers shall be used at the start for measuring.

One pyrometer is used by the judge at the start for the official measurement, and the second pyrometer is available for the athletes to check prior to official control and is operated by a judge or an individual assigned by a Technical Delegate.

The temperature of the steels is officially checked using a calibrated pyrometer in the start area. Each steel is checked at two locations; at the point where the bridges attach to the runners and may also be checked at any point on the steel that lies between the bridges.

After the temperature control, the steels must not be heated.

The temperature of the steel may not deviate by more than +5°C from the temperature measured at the calibrated steel. If the calibration steel temperature falls below -5°C, the steel temperature may remain at 0°C.

At the start area, a calibration steel corresponding to the contour of the runner is to be placed 0.5 m to 1.0 m above ground at a location shaded from sunlight and is used as a control reference for the measurement period. The temperature of the control steel must be first measured 30 minutes before the start.

The control measurement must be repeated every 15 minutes. The results are to be posted in degrees Celsius with accuracy to 1/10 of one degree in the measuring log a location visible to everyone eligible to be in the start area.

The completed measuring log must be signed by the judge and handed over to the Technical Delegate at the conclusion of the race, who must include it within the TD Report.

#### 1.2.3. Measuring the sled

Before each start, the sled is checked in the start area by the authorized judges using the official FIL measure instruments.

#### 1.2.4. Additional inspections

Random inspections of the entire sled may be carried out at any time by the Technical Delegate or by someone who they authorize.

### 1.3 **Command to start: “Start is clear”**

1.3.1 In FIL championships, World Cups, and all other FIL races, the start is initiated by “Start is clear”; only one athlete or one doubles team may be on the track at the same time.

1.3.2 The starter may only give permission to start when he/she has received the command “Finish is clear” from the finish.

1.3.3 In case of an interruption, the athletes’ preparation time is 1 minute.

### 1.4 **False Start**

If there is a false start and the fault does not lie with the athlete, the Start Leader immediately informs the Race Director who shall give instructions for a new start.

As soon as the athlete is ready to start again, the Race Director shall decide on the starting time of the run to be repeated.

### 1.5 **Start Assistance**

Any acceleration provided from a “third party” during either training or competition, is strictly forbidden.

## **1.6 Classic World Cup Format with Team Competition**

- 1.6.1 The starting order see 1.1.1  
After the command “Start is clear”, the athlete must trigger the timing system within 15 seconds.
- 1.6.2 A “false start” exists when the athlete passes the light barrier at the start before or after the given time window of 15 seconds (green light).  
If there is a false start, the Start Leader or the person authorized by the Technical Delegate immediately informs the Race Director.  
If the fault for the false start does not lie with the athlete, the athlete may repeat the run. As soon as the athlete is ready to start again, the Race Director shall decide on the starting time of the run to be repeated.
- 1.6.3 Starting procedure for Team Competition
- 1.6.3.1 Starting order  
Both sleds of the team (1<sup>st</sup> women’s, 2<sup>nd</sup> men’s) start one after the other.
- 1.6.3.2 Starting procedure  
The athlete may only start when the starting gate opens.  
The first sled (women’s) starts as follows:  
  
The Start Leader or a person designated by him/her (called Starter) asks the athlete: Ready? Bereit?  
The athlete confirms by pressing a button which causes the starting gate to open. The starting gate opens within a time window of 4 to 10 seconds after the button is pressed.  
Upon passing across the finish line, the athlete travels through a light barrier which triggers a contact to open the starting gate. The clock continues to run. The second sled may only start once the starting gate has opened.
- 1.6.3.3 False start  
A false start exists when the athlete touches the starting gate before it opens and triggers the contact for timekeeping.  
The Technical Delegate or his authorized representative who monitors the starting procedure documents the false start and reports it to the Race Director.  
Despite the recorded false start, the team must complete the race but is entered in the result list as DIS (disqualified).
- 1.6.3.4 Start facility/start gate  
The start gate is linked to the timing system. The technical equipment for connecting to the timing system at the finish line must be provided by the event organizer. The same holds true for the anchoring for the start gate. The start area must be laid out according to the drawing (Suppl 1, p. 40).  
The start ramp must be set up according to the accompanying drawings (Suppl 1, p. 40).  
At least two pairs of wires with a 1.5 mm<sup>2</sup> cross-section are required (line connecting the start to the finish line).  
The FIL shall provide the start gate.
- 1.7 Championships**  
The starting order see 1.1.1  
The starting procedure for championships is the same as the starting procedure for the classic World Cup format with a Team Competition.

## **1.8 Parallel competition**

- 1.8.1 Starting order for qualification:  
The starting order is the same as that in training (see §9, item 4).
- 1.8.2 Starting sequence for elimination runs:  
The athletes admitted to the elimination runs compete based on a grid where generally the fastest of 16 starters competes against the slowest from the qualification (given a full grid) (see 2.4.9).  
When there are 26 starters (with a full grid), the fastest 6 from the qualification are automatically qualified for the next round and are given a bye.
- 1.8.3 Starting procedure:  
Before the starter gives the command: “Achtung bereit” or “Ready, set” and then initiates the start, he must first ask the athletes if they are ready. This may be done in any preferred sequence: “Rot fertig”, “Red ready” and “Blau fertig”, “Blue ready”. The start command may only be issued after both athletes have responded with “ja” or “yes”.
- 1.8.4 The start is controlled by the Technical Delegate or his authorized representative together with the Start Leader. A standing area must be available between and directly behind the two gates from which the start area may be observed.
- 1.8.5 The start gates must open at the same time. Exception: A delayed start in the second run corresponding to a time difference is possible if the technical prerequisites exist.
- 1.8.6 Any start system may be used providing that an equivalent start is ensured for both runs.
- 1.8.7 If there is a demonstrable technical problem with one or both of the gates (a door opens too early or is blocked), the run shall be repeated.  
With timed runs, only the run of the athlete who had the technical problem with the gate shall be repeated; with elimination runs (based on a time difference), both athletes must repeat the run.
- 1.8.8 False start:  
A false start exists when an athlete independently opens the gate and starts the time before the gate automatically opens.
- 1.8.8.1 If there is a false start (early start) in the qualification runs, extra time (1.5 seconds if not otherwise specified) is added to the athlete’s run time, and he/she is placed after the worst time with two correct starts.  
If there are false starts for both runs (red and blue), the athlete is given the time penalty for each run and is placed after the athletes with one false start.  
If both athletes have a false start (in the same runs or runs at different times), the athlete with the better qualification time is entitled to enter the next round.  
If an athlete has two false starts and the other athlete has one, the time penalty rule applies.  
In the event of four false starts (each athlete has two), the qualification time applies.



	Qualification		Elimination runs	
False start in the 1st run	Time penalty assessed	Placed behind the worst time with two correct starts (run time plus penalty)	Time penalty assessed	
False start in the 2nd run	Time penalty assessed	Placed behind the worst time with two correct starts (run time plus penalty)	Time penalty assessed	
Both athletes had a false start (simultaneous or at different times), or both athletes have two false starts each	Time penalty assessed for each false start	Placed behind the worst time with two correct starts (run time plus penalty)	Run times are not counted	The better qualification time determines who advances to the next round
One athlete has a false start, and the other has two	Time penalty for each false start	Placed behind the worst time with two correct starts (run time plus penalty)	Time penalty assessed	

## 1.9 Eliminator competition

### 1.9.1 Starting order Qualification

#### 1.9.1.1 WC eliminator race as an individual event

The starting order in the qualification corresponds to the starting order of the training runs.

#### 1.9.1.2 WC eliminator race as double World Cup in connection with classic format:

The qualification results from the ranking in the overall World Cup point list.

### 1.9.2 Starting order competition runs

#### 1.9.2.1 WC eliminator race as an individual event

In competition runs, the starting order is dictated by the qualification times or the times from the previous round. The athlete with the slowest time starts first, the second slowest starts next, etc. If the times are the same, a random draw is made by the computer.

#### 1.9.2.2 WC eliminator race as double World Cup in connection with classic format:

In the competition runs, the starting order is determined by the rankings in the overall World Cup list and the previous round. The runner with the worse ranking or slower time starts first, the runner with the better ranking or faster time starts second, and so on. If the times are the same, a random draw is made by the computer.

### 1.9.3 Starting procedure

(see 1.6.1 Classic format)

### 1.9.4 False start

(see 1.6.2 Classic format)

## **2. Sliding Rules and Procedures**

### **2.1 General Regulations**

- 2.1.1 During all FIL Championships, World Cups and other FIL competitions, the competitor must travel on his/her sled from the start to the finish in a seated or reclined position. Interruptions caused by a crash on the track are not grounds for disqualification.
- 2.1.2 The athlete must pass the finish line in contact with his/her sled.  
If the athlete or sled leaves the track during the run and thereby interrupts the run, the run may not be continued.
- 2.1.3 Departure from the sled  
If the athlete crashes and is unable to make his or her sled slide due to the insufficient inclination of the track, snow conditions or other factors, the athlete may commence sliding with a running start.  
Third party assistance is forbidden.
- 2.1.4 During both training and competition runs, an actual physical connection between an athlete and their sled is permitted only if the connection immediately releases itself in the event of a crash. (i.e.: Velcro)
- 2.1.5 It is forbidden to use a short-cut between start and finish.
- 2.1.6 Modification and exchange of the sled  
Exchanging or modifying a sled between the runs of a competition is permitted.
- 2.1.7 Behavior and conduct  
Every participating athlete and official must behave in a fair manner during a competition and during training. Violations of the "fair play" principle will be investigated and will result in appropriate sanctions.
- 2.1.8 Competitions may be held in all weather conditions and in temperatures down to -25 degrees centigrade. In the event of colder temperatures, the Race Director shall render a decision only after consultation with the Technical Delegates and the Team Captains.
- 2.1.9 A camera run may be authorized under the responsibility of the film crew and in consultation with the sports director, the TD and the race director

### **2.2 Classic World Cup Format with Team Competition**

- 2.2.1 Authorization to participate in the World Cup final run (second competition run) per nation (including seeded); maximum number of entries for nation, size of the field of participants

	Women's	Men's	Doubles
Number of World Cup participants per nation	4	4	3
Maximum permissible entries per nation	6	6	4
Maximum number of participants in the final run (2nd comp. run)	26	26	16

- 2.2.2 Seeded athletes:
- Women's: The nations ranking 1-10 in the women's division at the last World Cup national ranking seed 1 woman each
- Men's: The nations ranking 1-10 in the men's division at the last World Cup national ranking seed 1 man each
- Doubles: The doubles competition does not have any seeded athletes
- The national ranking is reconfigured after three World Cup races and at the beginning of the season, and the number of seeded athletes is reset for every category.
- 2.2.3 The current names of the seeded athletes are identified as follows:
- 2.2.3.1 Women from nations ranking 1-10, corresponding to the last women's World Cup nations ranking:  
 From the World Cup total points ranking of the women according to the final tally of the current World Cup overall ranking  
 If the points are equivalent, the seeded athletes shall be determined as follows for the relevant race:  
 - the fastest qualification run time breaks the tie.  
 - if the qualification run times are the same, the fastest training run time breaks the tie.  
 Should any athlete(s) be missing from the women's seeded group, no non-seeded athlete(s) shall move up. The seeded places are assigned by name based on the above-described overall point ranking and are non-transferable.
- 2.2.3.2 Men from nations ranking 1-10, corresponding to the last men's World Cup nations ranking:  
 From the World Cup total points ranking of the men according to the final tally of the current World Cup overall ranking  
 If the points are equivalent, the seeded athletes shall be determined as follows for the relevant race:  
 - the fastest qualification run time breaks the tie.  
 - if the qualification run times are the same, the fastest training run time breaks the tie.
- Should any athlete(s) be missing from the men's seeded group, no non-seeded athlete(s) shall move up. The seeded places are assigned by name based on the above-described overall point ranking and are non-transferable.
- 2.2.4 1st run (qualification run WC/NC)  
 In the training run and the first competition run (qualification run), the starting order shall follow the current World Cup overall ranking in reverse order.  
 The athletes retain their start numbers during the entire World Cup event (WC + NC).
- 2.2.5 Participation in the second run (World Cup final run)  
 In addition to the athletes who have already been seeded, the fastest women, men and doubles qualify for the finals (second competition run) to reach a quota of 26 women, 26 men and 16 doubles; the maximum permissible number in each discipline per nation may not be exceeded. In the event of tied times in the first run (qualification run) for the last starting place in the finals, the result of the last training run shall be the tiebreaker.
- 2.2.6 Nations Cup  
 All athletes who did not qualify for the second competition run (World Cup finals) are ranked in the Nations Cup.

## 2.3 **Championships**

There are at least two training runs for championships.

Continental Championships (General Class and Junior's) are held with two competition runs, and World Championships (General Class and Junior's) are held with three competition runs.

Only the 26 best women, 26 best men, and 16 best doubles are eligible for the final run.

### 2.3.1 Team Competition:

see (WC classic format under 1.6.3 et seq.)

## 2.4 **Parallel competition**

### 2.4.1 Selection and preparation of the track

A sufficiently wide, preferably slightly concave slope should be chosen for parallel competitions (which makes it possible to oversee the entire competition from all locations).

Elevations and changes in slope must extend across the entire width of the track.

Each track must have similar profiles and similar difficulties.

### 2.4.2 The track must be completely boarded.

It is recommended that a second wall be set up along the run for coaches, athletes and service personnel.

### 2.4.3 A member of the Track Construction Commission must be involved when designing and constructing each track. The tracks must be constructed sufficiently early and should be approximately 300 m long and each track at least 3 m wide.

### 2.4.4 The left track (viewed from above) is the red track, and the right track is the blue track, and each should be clearly identified as such.

### 2.4.5 Holding the competition

The decision between each pair of athletes is carried out over two runs, and both athletes switch tracks for the second run.

Their 'time' always refers to the total of the time on the red track plus the time on the blue track.

### 2.4.6 Qualification

Each athlete has one run on each track.

### 2.4.7 The start order of the athletes corresponds to their World Cup points.

In the event of discretionary placements at rank 16 (doubles) or 26 (women/men) in the qualification, the better training time in the last training session before qualification serves as the tie-breaker.

### 2.4.8 A qualification list (results list) is prepared.

### 2.4.9 Parallel elimination runs

The grids for the elimination runs are prepared as follows based on the qualification results lists.

Pairings with 16 starters (doubles)
1 against 16
8 against 9
5 against 12
4 against 13
3 against 14
6 against 11
7 against 10
2 against 15

Pairings with 26 starters (women's/ men's)
1 bye
16 against 17
9 against 24
8 against 25
5 bye
12 against 21
4 bye
13 against 20
3 bye
14 against 19
11 against 22
6 bye
7 against 26
10 against 23
15 against 18
2 bye

- 2.4.10 An athlete who does not complete the first run, or drops out, shall start the second run with a time penalty of 1.5 seconds.
- 2.4.11 For each pairing in the first round, the athlete with a better qualification time shall compete first on the red course. The athletes shall then switch courses for the second run. Each run in the parallel finals must use this system.

	Qualification		Elimination runs
Crash in the first run	DNF 1, but may compete in the second run	Ranked at the end corresponding to the time of the run, but may start in the main competition (if within the quota)	Time penalty assessed, but may compete in the second run

Crash in the second run	DNF 2	Ranked at the end corresponding to the time of the run, but may start in the main competition (if within the quota)	DNF
-------------------------	-------	---	-----

- 2.4.12 The winners of each round advance to the next round until the victor is established.
- 2.4.13 If the time difference between both athletes in a pairing requires a discretionary decision after the second run, the winner of the second round advances to the next round.
- 2.4.14 Semifinals and finals  
The winners of the semifinal runs move to first place, and the losers move to third place.
- 2.4.15 Time penalty  
The time penalty for women's, men's and doubles is 1.5 seconds.

## 2.5 Eliminator Competition

- 2.5.1 WC eliminator race as an individual event:  
The participants qualify in a qualification race in which the fastest 4 men, 4 women, and 3 doubles per nation are admitted to the World Cup, provided they are placed in the top 26/26/16. All non-qualified athletes will be classified for the Nations Cup.
- 2.5.2 WC eliminator Race as a double World Cup in combination with classic format:  
The participants qualify on the basis of the overall World Cup standings, whereby the best 4 men, 4 women, and 3 doubles per nation are admitted to the World Cup, provided they are placed in the top 26/26/16. All non-qualified athletes can participate in the Nations Cup, which is held in a single heat before the eliminator. The ranking will be based on the run times
- 2.5.3 Should fewer than 26 men, 26 women, or 16 doubles qualify for the competition, those runners who have no opponent will receive a bye (e.g. 7<sup>th</sup> women's or 7<sup>th</sup> men's or 1<sup>st</sup> doubles etc.) until the field is complete for the second round (16 men, 16 women, 8 doubles).

For the starting order in the next round, into which the athlete has advanced by means of a bye, the fastest time of the completed run (Qualification or first round) will be used.

- 2.5.4 Training and qualification:  
There are two training runs before the qualification run.  
If track conditions prevent two training runs from taking place, one training run must at least take place, otherwise the World Cup shall not be held.  
  
No training runs may be held for double events (eliminator races combined with a classic World Cup). (see para.9 sect. 4.4.2)
- 2.5.1 Starting order for training and qualification: The starting order corresponds to the overall World Cup ranking per discipline. (that is, the men start in the reverse sequence of the men's overall World Cup ranking). If the number of points is equal, a computer shall decide the draw.

### 2.5.5 Competition runs:

- 2.5.5.1 The starting order for the race is created from the grid on page 28-29, para. 1.4.9.

- 2.5.5.2 The better/faster athlete advances to the next round. In the event of a tie, the athlete advances who started second in the duel (= the hunted athlete, the athlete who had the better time or the better ranking in the previous round)
- 2.5.5.3 If both athletes in the grid are disqualified or eliminated, the next competitor is given a bye. (He must nevertheless complete his run).
- 2.5.5.4 The winners of each round advance to the next round until the final round. There will be three rounds for doubles and four for the women and the men, followed by the final round.
- 2.5.5.5 Final round: There are 4 athletes left for the final round, they will compete for places 1 to 4, the start order in the final will be determined by the times of the previous round. In the event of a tie, the computer draw will decide, i.e. the fourth athlete will start, then the third, etc. The ranking is based on the times, there are no direct duels in the final round. In case of tie there will be an ex aequo placement on the respective rank.

### **3. Finish line**

#### **3.1 General rules**

- 3.1.1 The finish line is defined by the light barrier and a colored finish line. The finish line must also be identified in an easily visible manner by a finish line banner, etc.
- 3.1.2 The athlete must pass the finish line in contact with his/her sled. In doubles competitions, both athletes must cross the finish line in contact with the sled; the seating arrangement (front and back position) is irrelevant.

#### **3.2 Parallel competition**

- 3.2.1 The finish lines must be parallel.
- 3.2.2 Each track's finish must be identified by a banner strung between two posts (finish line). Both finishes must be at least 4 m wide.
- 3.2.3 For reasons of safety, the finishes are visually different.

### **4. Timekeeping and Identifying the Winner**

#### **4.1 General Rules**

- 4.1.1 The timing system must be automated and record the time: The start time, no intermediate times depending on the length of the track (parallel), one intermediate time (short runs) or two intermediate times (classic format), and the final time, and provide accuracy of 1/100th of a second. During both training and competition the position of the official start and finish line timing lights must be marked in colour across the entire surface of the track. The timing system must function and be installed in accordance with the timekeeping manual.
- 4.1.2 The timing system must be ready and tested at least one hour before the beginning of the event.
- 4.1.3 In addition to the primary electronic timing system, a secondary timing system is required. The secondary timing system must also be an electronic system that functions independent to the main timing system.

- 4.1.4 The timekeeper must immediately notify the Race Director of any problems that occur with the timing system, and the Race Director must then interrupt the race until the timing system functions properly.  
Should a problem occur with the primary timing system, the times provided by the secondary timing system shall be used for athletes who finish their run.  
If no time is recorded for an athlete, the athlete may repeat the run in consultation with the Race Director.
- 4.1.5 Team officials and athletes are forbidden from accessing both the timing facilities and the official timing system(s).
- 4.1.6 The first and last names as well as the start numbers of athletes who have dropped out or were disqualified are to be entered in the results list with the times achieved up to that point.
- Athletes are classified as “dropped out” for the following reasons:
- Did not start (for example, due to illness and injury) (DNS)
  - Not started (training barred pursuant to §4(1.2.4) (not st.)
  - Did not finish (DNF)
  - Disqualified (DIS)
- 4.1.7 All official results lists (competition runs) must be signed by the Race Director and the Chairman of the jury. The members of the jury and the Technical Delegate(s) must be listed by name.
- 4.1.8 First and last names of all athletes must be entered on the results list. The official results lists must contain the following information:
- Name, date and location of the event
  - Club holding the event
  - FIL representative
  - Chairperson and members of the jury (including their name and country)
  - Technical Delegates (name and country)
  - Race Director, Start Leader, Finish Leader, Chief of the Track
  - Number of participants registered for the run, number of rated participants, number of participants who dropped out
- 4.1.9 Each National Federation is to be provided with official results lists after the conclusion of the competition.  
One copy is to be provided to the FIL office, the Natural Track Director, the Sports and Technical Commission, and the FIL press official.
- 4.1.10 All times officially measured for each athlete must be recorded in writing.  
All documents that provide records are to be used in reviews and to address protests. Records must be archived by the organizer for at least one year following the competition.
- 4.2. Determining the Victor**
- 4.2.1 Classic World Cup format for Team Competition  
Official results are generated in the classic World Cup format from the totaled times achieved by the athletes in the competition runs; the results for Team Competitions are generated from the totaled times of the two starters of the team. If two or more athletes have the same overall time, they shall be awarded the same place.



- 4.2.2 **Championships**  
The official results are generated from the totaled times achieved by the athletes in the competition runs; the results for Team Competitions are generated from the total time of the two starters of the team. If two or more athletes have the same overall time, they shall be awarded the same place.
- 4.2.3 **Parallel competition**
- 4.2.3.1 Places 5-8, 9-16 and 17-26 are awarded based on the times of the qualification runs. An athlete who qualified for an additional round always remains in this round even if his or her qualification time was faster than the qualification time of one or more athletes in a group with a poorer performance (Example: Whoever qualified for the round of the best 8 remains in this group).
- 4.2.3.2 Athletes who do not finish the race (DNF/DIS/DNS) are placed at the end and are not awarded any World Cup points. The spaces that are made available are filled by the athletes who are next in line.
- 4.2.4. **Eliminator races**
- 4.2.4.1 For eliminator races, the victor is determined according to the rules as per 2.5 et seq.
- 4.2.4.2 Places 5-8, 9-16 and 17-28 will be ranked in blocks according to the times of the last round in which they were eliminated. (Example: Whoever qualifies for the round of the best 8 once, stays in this group. If an athlete does not have a time, for whatever reason (e.g. DNS, DNF) the athlete will be ranked last from the block).
- 4.2.4.3 The World Cup points at the Nations Cup will be awarded with the 17th place for doubles and with the 27th place for women and men, regardless of whether the World Cup quota of 16 or 26 athletes was fulfilled or not.

### **4.3 Results with a Reduced Number of Competition Runs**

- 4.3.1 **Classic World Cup format with Team Competition:**  
If a final run cannot be held because the number of competition runs has been reduced, the results list shall be based on qualification. The athletes qualified for the final run shall be ranked according to their qualification times; athletes who did not qualify shall be ranked in the Nations Cup (same start lists for the World Cup and Nations Cup).
- 4.3.2 **Championships:**  
If the number of competition runs is reduced, the final ranking shall correspond to the times achieved in the preceding completed runs.
- 4.3.3 **Parallel competition:**  
If the competition terminates prematurely, the concluded groups (eighth-finals, quarterfinals, etc.) are ranked according to the classification rules as per 4.2.3. The groups that did not yet participate are ranked according to the qualification times.
- 4.3.4 **Eliminator race:**  
If the competition terminates prematurely, the athletes who have already been eliminated are ranked according to the classification rules as per 2.5.5. The group of athletes who did not compete are ranked according to their times from the previous round (analogous to the start list).

**1.        Reason for a Protest**

If an athlete feels that his or her rights as detailed in the IRO have been infringed upon during official training, a competition run or for any other reason during a competition, the Team Captain or his or her authorized representative of the respective National Federation has the right to protest.

The Team Captain is the individual who represents the National Federation in the first Team Captain meeting.

The flash from a camera does not constitute grounds for a protest.

The jury is responsible for resolving protests.

**2.        Procedure**

2.1        Protests must be made in writing and must be dated and signed by the Team Captain or the Team Captain's authorized representative.

2.2        The protest is presented to the Jury Chairperson who confirms receipt with the date, time and a signature.

2.3        A protest fee of €60 or the equivalent in a convertible currency must be submitted with the protest.

2.4        The written protest must be submitted within 10 minutes after the official training, or competition run, or other occasion for protest, or once the reason for the protest becomes known.

If the reason for the protest is a disqualification by the Race Director, the 10-minute period shall commence upon publication on the official information board following completion of a competition run.

**3.        Settlement**

3.1        The Jury shall meet to render a decision within one hour after the protest is submitted. If the demonstrable reason for the protest only becomes known after the aforementioned 10-minute period, the Jury must still address the protest. The awards ceremony constitutes the conclusion of the competition and is the deadline for protests.

3.2        The Jury may avail itself of any persons or items associated with a protest at the location to help clarify the subject matter of the protest.

In the case of a protest, the Jury must decide whether any pieces of evidence presented (such as films, pictures, video records, etc.) are to be accepted.

However, this material is only used to assist in making their decision.

3.3        The decision of the Jury regarding protests is final and may only be contested according to the bylaws and procedures of the FIL.

The Jury's decision must be submitted to the protesting individual in writing (protest supplement form).

3.4        The protest fee is returned in its entirety if the protest is decided in favour of the protesting party.

3.5        If the protest is denied, the protest fee is forfeited and is remitted to the event organizer.

3.6        If events or violations contrary to the IRO are discovered after the conclusion of the competition (last awards ceremony), then the FIL Executive Board shall make the decision.

## § 12 Awarding the Title and Awards Ceremony

### 1. **Title for General Class and Junior World Championships:**

Titles are to be awarded for the following:

- 1.1 Men's Singles with the title
  - "World Champion in Men's Singles"
  - "Junior World Champion in Men's Singles"
- 1.2 Women's Singles with the title
  - "World Champion in Women's Singles"
  - "Junior World Champion in Women's Singles"
- 1.3 Doubles with the title
  - "World Champion in Doubles"
  - "Junior World Champion in Doubles"

Both athletes are awarded the same title and same distinctions.
- 1.3 Team Competition with the title
  - "World Champion in Team Competition"

The athletes are awarded the same title and same distinctions.

### 2. **Title for Continental Championships**

The titles for Continental Championships are awarded according to the same protocol.

### 3. **Awarding Titles when there are Fewer Competition Runs**

When the number of competition runs in any discipline is reduced, titles are only awarded if all athletes have participated in at least one run.

### 4. **Certificates**

- 4.1 The certificate is the written proof that the named athlete has participated in a championship or competition. The certificate must contain the following:
  - Name of the event organizer
  - Type of championship or competition and the discipline
  - Name of the athlete
  - Rank achieved by the athlete in the final classification
  - Signature of the FIL Representative, Chairman of the Jury and Race Director
  - Location and date of the event.
- 4.2 Each athlete and official who has participated in a championship must receive a certificate.

### 5. **Medals**

- 5.1 In FIL championships (World Championships, General Class and Junior Continental Championships) and the overall World Cup (General Class and Junior's), medals and trophies are awarded for first through third place.

These medals (trophies) are provided by the FIL.

- 5.2 For the individual World Cups (General Class and Junior's), trophies (or medals) are awarded for first through third place. They must show the following:

- race title and discipline of the competition
- placing
- location and year.

These trophies are provided by the event organizer.

**6. Pins**

The organizers can provide pins for athletes, officials and supervisors who participate in a World Championship, Junior World Championship or Continental Championship.

**7. Gifts of Honor and Remembrance**

The organizers are permitted to give participants in FIL Championships and FIL competitions honors and mementos.

**8. Awards Ceremony and Conclusion of the Event**

8.1 The organizers must announce the winner (flowers ceremony) immediately after each final competition in the finish area as follows:

8.2 The winners, second and third place holders of each discipline are to be awarded as follows:

- At the awards ceremony of all FIL championships and competitions, the flags must be raised of the National Federations of the champion and second and third place finishers, and the national anthem of the winner must be played during the winner's ceremony.
- There is no awards ceremony if fewer than three athletes placed in the discipline.
- In exceptional circumstances, and after consulting the Natural Track Sports Director, it is permissible to hold the official awards ceremony in conjunction with the flowers ceremony.
- If two athletes are tied for first place, both national anthems shall be played in alphabetical order of the last name of the athletes. For doubles, the family name of the individual in front position shall be used. In a tie, both flags must be raised on the winners' pole.

8.3 The same procedure may be used for other international competitions.

8.4 The top three finishers for each discipline are to be awarded medals, generally by the FIL representative. In his absence, the Jury Chairperson awards them in a festive ceremony.

8.5 The champions in the overall World Cup in the men's, women's, and doubles' disciplines receive World Cup trophies.  
The athletes who placed second and third are also awarded a trophy. The top three ranked athletes in each discipline receive medals in gold, silver, and bronze.  
The World Cup trophies and medals shall be awarded at the awards ceremony of the World Cup final.  
The World Cup trophies and medals are provided by the FIL.

8.6 The victors of the overall Junior World Cup in luge as well as the second and third place athletes in women's, men's and doubles are awarded trophies.  
These trophies are provided by the FIL at the Junior World Cup luge finals.

8.7 The winners of the individual classes in the FIL Youth Games are given plaques and honorary awards which are provided by the event organizer.

8.8 As a conclusion of the awards ceremony and symbolic final act at FIL championships, the FIL flag is ceremonially handed over by the President or his representative to the representative of the National Federation who shall be organizing the next FIL championships.

## **§ 13 Concluding Regulations**

1. The IRO Natural Track is available in German and English. In case of a lack of clarity or contradictions, the German text is binding.
2. Resolutions regarding amendments and additions to the IRO Natural Track shall only be made by an ordinary Congress and require a simple majority, if the priority regulations of the FIL statutes do not state otherwise. Emergency motions to change the IRO Natural Track are only permitted in adherence to the FIL statutes.
3. In substantiated exceptional cases, changes in the IRO may be decided by the FIL Executive Board upon proposal by the appropriate expert commission. They will be presented for ratification at the next FIL Congress. The same is valid in case of controversial interpretations, contradictions and omissions in the regulations of the IRO Natural Track.
4. Changes and additions to the IRO Natural Track become valid at the beginning of the following sport year, July 1<sup>st</sup>.
5. This edition of the IRO Natural Track becomes valid on July 1<sup>st</sup>, 2024. At the same time, the former regulations of the IRO become invalid.

# Supplement 1

## Regulations for Natural Luge Tracks

### 1. General

All competitions sanctioned by the FIL shall be staged on tracks which are approved and commissioned by the FIL.

### 2. Definition of Natural Luge Tracks

Natural luge tracks are tracks which follow the natural terrain.

### 3. Tracks

Natural tracks that do not comply with the following regulations in part, can still be homologated. The deviations must be recorded in a corresponding report during homologation and enclosed with the homologation.

#### 3.1 Length:

Classic World Cup Format 400 m - 1200 m

Parallel competition approx. 300 m

Eliminator competition 300 – 600 m

Shorter tracks up to a length of at least 250 meters can be approved by the FIL (TD, jury, sports director, and race director) due to weather conditions.)

#### 3.2 Width: minimum of 3 m.

#### 3.3 Average drop: maximum of 13%

#### 3.4 Maximum drop: 25%

#### 3.5 Curve radii: minimum of 7 m calculated from the middle of the track.

#### 3.6 The following elements should be included:

- left curve
- right curve
- sharp bends (left and right)
- curve combination
- straightaway.

#### 3.7 Artificially-raised curves are not permitted.

#### 3.8 The bottom of the curves should be horizontal.

#### 3.9 The braking areas should be designed as flat as possible.

#### 3.10 The finish outrun should be prepared like the track, which means as horizontal as possible, so that the athlete can safely brake after crossing the finish line.

- 3.11 The usage of cooling systems for refrigeration of the track is allowed in short portions of the track.  
Agents and additives which will be used to support the refrigeration of the track's base must be environmentally-friendly in their nature, amount, and application forms.
- 3.12 At least 80 LUX must be set for the lighting power at luge tracks.  
In order to meet the technical needs of television, the lighting power must be increased at specific sites in accordance with technical requirements.  
In case of power failure, sufficient lighting, supplied from an independent source, must be guaranteed.  
Power supplies must be inspected and certified by a licensed electrician and evidence submitted in writing to the Technical Delegate.

#### **4. Condition of the Track**

- 4.1 For the final training run, the track should be prepared as it will be for the first competition run. Between the competition runs, the surface of the track - if necessary - has to be repaired (e.g. overrun, braking areas etc.).
- 4.2 Should weather conditions, such as snow, thaw, etc., create unequal conditions for individual athletes during a race, the organizers must provide a readily available work crew of appropriate size to ensure the consistent condition of the track.
- 4.3 The decision on the start and rhythm of the sweeping of the track lies with the Technical Delegates in conjunction with the race director; it must be determined and announced to the team captains over the track loudspeaker. Alterations which happen through the immediate use of the track must be corrected within the run of a discipline or at least after the run and under the supervision of a TD.
- 4.4 Any conscious unauthorized change to the surface of the track during a race is forbidden.

#### **5. Start Facilities**

- 5.1 The track must be equipped with all the necessary start facilities to guarantee a flawless staging of the competition.
- 5.2 During competitions, the starting area must be closed off so that only persons with authorized access can enter the starting area (area approx. 200 m<sup>2</sup>).  
The use of walkie-talkies and mobile phones is forbidden in this starting area.  
Smoking is forbidden within the closed-off starting area.
- 5.3 Individual components of the start facilities are (compare drawings in supplement 1, p 43):
- A horizontal iced surface on which the athlete may sit on his/her sled.
  - Length of the iced surface to the start handles: at least 2000 mm
  - Length of the iced surface from the start handles to the beginning of the descent: 500 mm.  
The transition from the start surface to the descent must be gradual.
  - Two start handles adjustable in height and width on either side of the start area which may be used by the athletes to increase the speed of their start.
  - From the ice surface to the upper edge of the handles at an equal height: 200 mm – 220 mm
  - Inside distance between the handles: adjustable between 740 mm – 800 mm
  - Length of the handle: at least 150 mm
  - Diameter of the handles: 25-30 mm
  - Upper surface of the handles must be grooved.
  - The construction of the handles must be so solid that it may not be bent upon the athletes' pull off.

- The construction must be adjustable in a horizontal and vertical direction, so that the indicated measurements can be adhered to.
  - The timing equipment must be installed no further than 5 m after the start handles.
  - For team and parallel competition, compare drawings 4 and 5.
- 5.4 If the start of a competition is carried out with the command “start is clear”, the following additional facilities must exist:

- A signal horn which clears the track acoustically for the athletes.
- Lights (red-green) which clear the track visually for the athletes.
- A device which triggers the start clock simultaneously with the signal horn and green light, and which counts down from 15 to 0 seconds.  
The athlete must trigger the timer at the start within these 15 seconds.  
When the time-keeping is triggered, the start clock must stop automatically and the lights must switch to red.

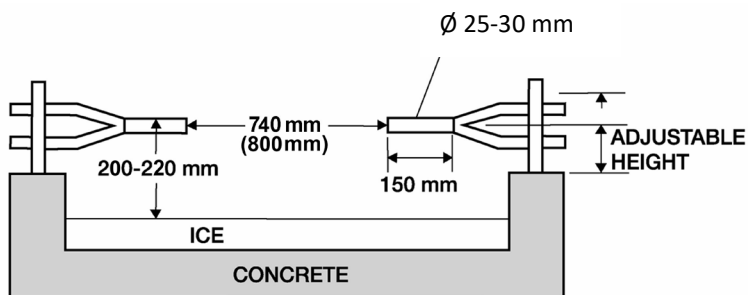
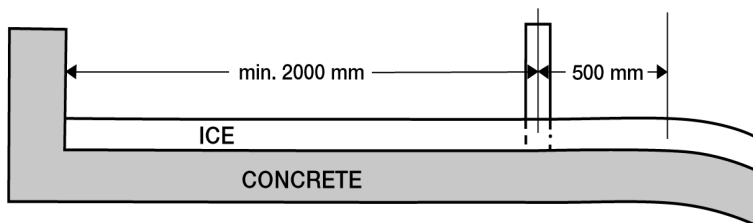

## 6. Safety Regulations

- 6.1 The track must be designed in such a way that exposed places are as safe as possible and meet the internationally-recognized safety standards by means of vertical protection walls and/or sufficiently large crash areas.
- 6.2 In exposed places, the protection walls must be built up in accordance with internationally accepted safety standards. The protection walls can be built with wood, glued wood, or plastic. The material has to be strong enough to withstand an impact.
- 6.3 The protection wall must follow the course of the curve.
- 6.4 The track must be declared clear for training and competition in writing. For this purpose, an official record is to be prepared with the following wording:



“The track has been inspected, especially its condition and the securing of dangerous sections. During the inspection of the track, it was determined that during regular usage of the track, including the finish run, no unusual safety risks will arise. Therefore the track is declared open.” Place, date, time, and appropriate signatures must be included in this statement.

This record must be signed by the Technical Delegate and the Race Director prior to the use of the track.

- 6.5 A sufficient number of observation points equipped with walkie-talkies or other suitable means of communication, equipment for clearing the snow have to be positioned along the track.

## **7. Construction Measures along the Track**

- 7.1 Along the track, a broad path has to be provided in order to ensure that
- the athletes can get up to the start quickly,
  - the medical services can have quick access along the entire track,
  - the officials can observe the race,
  - the track crew can stand safely,
  - the spectators can walk up along the track.

- 7.2 There must be sufficient lighting conditions for night runs. (see 3.12)

- 7.3 A sufficient number of parking spaces must be created in the start and finish areas.

## **8. Homologation of Natural Tracks**

- 8.1 The FIL Executive Board decides on official recognition and approval of a natural luge track for FIL Championships and FIL competitions after the track has been examined by representatives of the Track Construction Commission of the FIL.  
No liability is assumed by the FIL when providing the expert opinion homologation.

- 8.2 For the homologation of a natural luge track, a request must be made to the FIL which will then forward the request to the FIL Natural Track Construction Commission.  
They will then send suitable experts, who will carry out the homologation.

- 8.3 The full homologation procedure includes an examination of the planning documents, a track examination during summer construction and a homologation after the completion of the work.  
The track operator assumes the expenses, which are to be settled according to the FIL regulations on travel expenses.

- 8.4 The track operators are to receive a homologation certificate concerning the homologation of a natural luge track, and all documents about the track will be stored in archives and included in a catalogue (against payment of a fee).

- 8.5 This procedure is to be applied not only for new constructions, but also for alterations.

- 8.6 The homologation is valid for 5 years and must be renewed after that.

## Supplement 2

### Rules for Instruction of International Judges

#### 1. **Basics**

- 1.1 The training regulation of the FIL is an obligatory work document for all National Federations associated with the FIL.
- 1.2 During all FIL competitions, judges from the respective NFs may only be appointed if they possess FIL International Judge Licenses acquired in accordance with these instruction regulations.
- 1.3 The NFs associated with the FIL have the right to conduct the instruction and qualification of international judges under their own responsibility.
- 1.4 Only persons who are full members of NFs associated with the FIL may be admitted to instruction and qualification as an International Judge.
- 1.5 Issuing of the International Judge's License to the applicant is made after a valid examination and is not transferable.
- 1.6 The FIL may withdraw an International Judge's License for gross infractions, unsportsmanship-like ethics and morals in the conduct of one's duties.  
The International Judge's license can also be withdrawn if after several years, the respective judge cannot prove that he has officiated and/or has not participated in refresher or repetitive training.

#### 2. **Instruction**

- 2.1 The task of the NF is to select qualified persons who may be enrolled for instruction and qualification by the NFs for the International Judge's License. The number of International Judge's instructed by a NF is not limited.
- 2.2 For instruction and qualification, the NF must appoint a head instructor and two assistants who have the necessary specialized knowledge to instruct the applicants.
- 2.3 The instruction and qualification of applicants for the International Judge's License are to be carried out by the NF.  
The instruction and qualification must be under the supervision of the NF in accordance with the lesson plan of these instruction regulations and must not be less than the prescribed 22 hours of instruction.
- 2.4 The period of instruction and qualification may not exceed six months measured from the beginning of instruction to the conclusion of the test.

#### 3. **Lesson Plan**

- 3.1 All Sections of the IRO.
- 3.2 All Supplements of the IRO.
- 3.3 Practical work with measuring devices.

3.4 Working during a FIL competition with the assignment of special tasks and discussions.

#### **4. Composition of the Examination Commission**

4.1 FIL Proctor

4.2 Chairperson of the Examination Commission

4.3 First assistant to the chairperson

4.4 Second assistant to the chairperson

#### **5. Responsibilities of the Examination Commission**

5.1 An Examination Commission is appointed by the NF to administer the final examination of the applicants. As a rule, the head instructor should belong to this commission.

5.2 The chairperson of the Examination Commission must inform the FIL official responsible for the International Judges of the examination date at least eight (8) weeks in advance of the examination so that the FIL Proctor may be named and confirmed in writing to the NF. Expenses for the travel and accommodations of the FIL Proctor are assumed by the NF.

5.3 A record is to be made concerning the results of the examination and its execution. This report must include the signatures of the Examination Commission and the FIL Proctor with notation of the place and date of the examination.

5.4 The FIL Proctor has to send this record to the FIL office.

#### **6. Examination Regulations**

6.1 The examination is given in written and oral form.  
The examination documents are available at the FIL office.

6.2 The Examination Commission determines the length of time for the oral and written examination.

6.3 Candidates who use external aids during the examination will be disqualified.

6.4 The examination is passed when the applicant responds correctly to at least three quarters of the posed questions.

#### **7. Issuance of the International Judge License**

7.1 The FIL Proctor issues the International Judge's License and the International Judge's Badge to the applicants in question after they have successfully passed the examination.

7.2 The FIL distributes the International Judge License in the form of a passport identification booklet signed by the FIL President.

7.3 A list of FIL international judges is kept at the FIL office.

7.4 The FIL member NFs must grant International Judges free entry to FIL competitions upon presentation of their identification card even if they are not working at the event(s).

7.5 The FIL Executive Board can withdraw the International Judge's License from a judge if he engages himself/herself in activities which harm the reputation of the FIL.

8. **Assistant Judge**

The training to become an Assistant Judge involves training provided by the TD or a person authorized by the TD prior to the race and is only valid for this race. Each race organizer can present a list of possible candidates, but the TD can reject any person at any time. The content of the briefing is to teach candidates the use of the pyrometers and the use of the sled weight scale. The license is valid for the race at which the briefing took place.

## Supplement 3

### Regulations for Audio-Visual Media Rights

#### 1. General

- 1.1 The aim of the FIL is to promote the sport of luge worldwide. In order to come up to this challenge, it is necessary to establish uniform regulations for the coverage of the sport of luge via television, film, and other new media (i.e. internet), in order to achieve the best worldwide media presence.
- 1.2 If there are no other regulations, the FIL is the exclusive and worldwide owner of the rights for audio-visual media for all events taking place on behalf of or with the approval of the FIL. The following rights belong to the subject audio-visual media:
- television (free or Pay TV, all kinds of broadcasting, terrestrial, cable, satellite, etc.
  - film (all formats)
  - video (all systems including video games, etc.)
  - projection rights
  - movie and video pictures on the internet
- 1.3 If these regulations are not considered, the respective competition can be cancelled from the International FIL sport calendar for a certain period to be determined by the FIL Executive Board and/or it can result in sanctions against the respective NF.

#### 2. Awarding of Television Rights

- 2.1 **International Competitions** (with the exception of championships)
- 2.1.1 The FIL authorizes the NFs affiliated with the FIL to conclude contracts on the awarding of the television rights which concern television broadcasts of luge events - except FIL Championships and Olympic Winter Games - which the Federation organizes in its country for the broadcasting area within its own country. The NF can delegate this responsibility to individual organizations belonging to the Federation. For the handing over of television rights to television companies outside the organizing country, the FIL is solely responsible.
- 2.1.2 Prior to signing them, all contract drafts are to be presented to the FIL for approval. The FIL can only withhold its approval for just cause. Just cause would be, if the contract partner cannot furnish production and/or broadcasting guarantees (in sufficient technical quality) and/or the contract partner does not provide an international live signal. If within six months prior to the event no detailed contract offer is presented, the FIL reserves the right to award the contract itself.
- 2.1.3 The NF or the event organizer authorized by the NF is obliged to grant the FIL free access to the live signal (signal with graphics and voice according to international standards).
- 2.2. **Championships**  
Regarding agreement with television stations concerning the broadcasting rights of FIL Championships, the FIL Executive Board acts together with the organizing NF. The FIL Executive Board makes the final resolution.
- 2.3. **Commentator Booths**  
The NF or the event organizer authorized by the NF has to guarantee the FIL that sufficient commentator booths are available.

3. **Video, Film, and Other Rights**

After agreement by the FIL, the NF is authorized by the FIL to award the film and video rights in their own country as far as it is guaranteed that marketing these rights abroad is not possible.

4. **Short Reports**

The awarding of short report rights has to be done according to national and international regulations. If a respective request is made at the recording station, the FIL has to be informed at once.

5. **Financial Regulation**

5.1 **Television**

For championships, the FIL is obliged to give two-thirds of the net income of the sales of the television rights (after deduction of possible taxes or other relevant expenses) to the organizing NF.

5.2 **Video**

The FIL has to give two-thirds of the income of the selling of commercial film and video rights to the organizing national federation.

6. These regulations were acknowledged during the FIL Congress in Rome on June 24-25, 1994, and they were more precisely worded for the Congress in Colorado Springs in May 1998.

# Drawing 1

General class luge, juniors and doubles

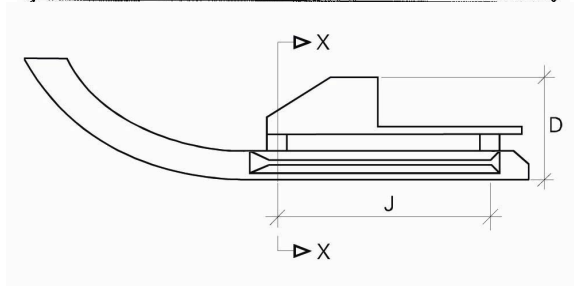
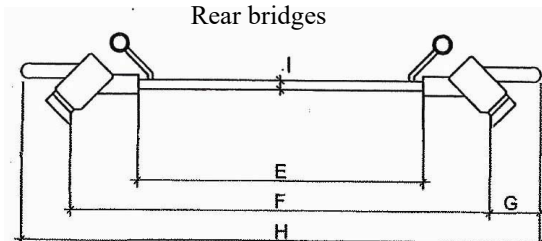
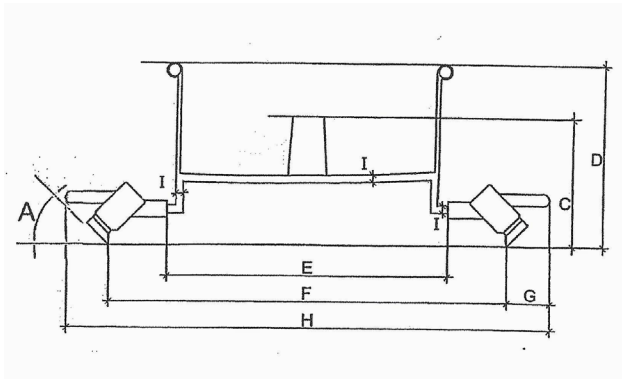
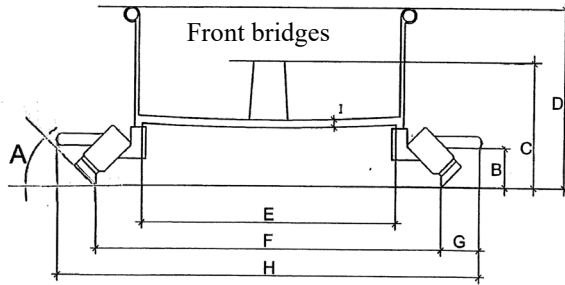

# Drawing 2

Youth luge (non-offset runners)

### Front bridges

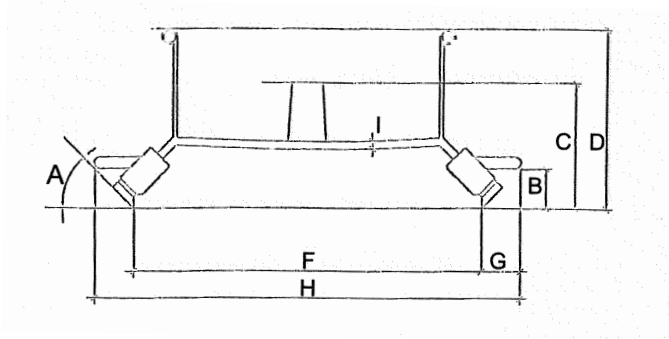

### Rear bridges

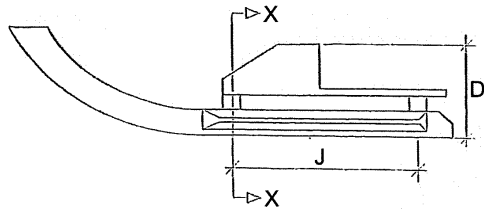
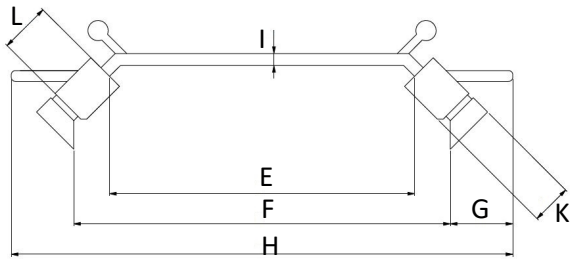



# Drawing 3

## Steel geometry

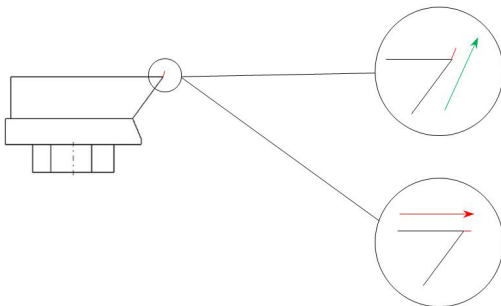
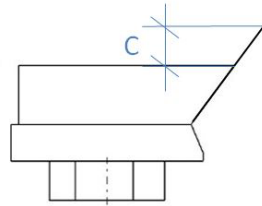
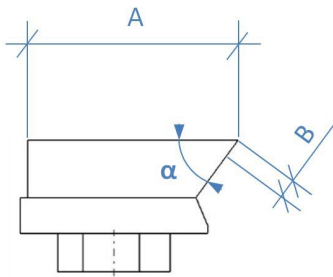
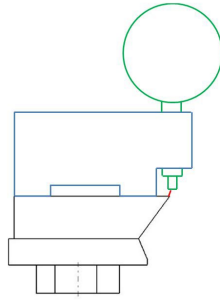

Burr as extension of the inner edge

OK !

Burr as extension of the running surface

Prohibited !

# Drawing 4

## Start gates for team competition

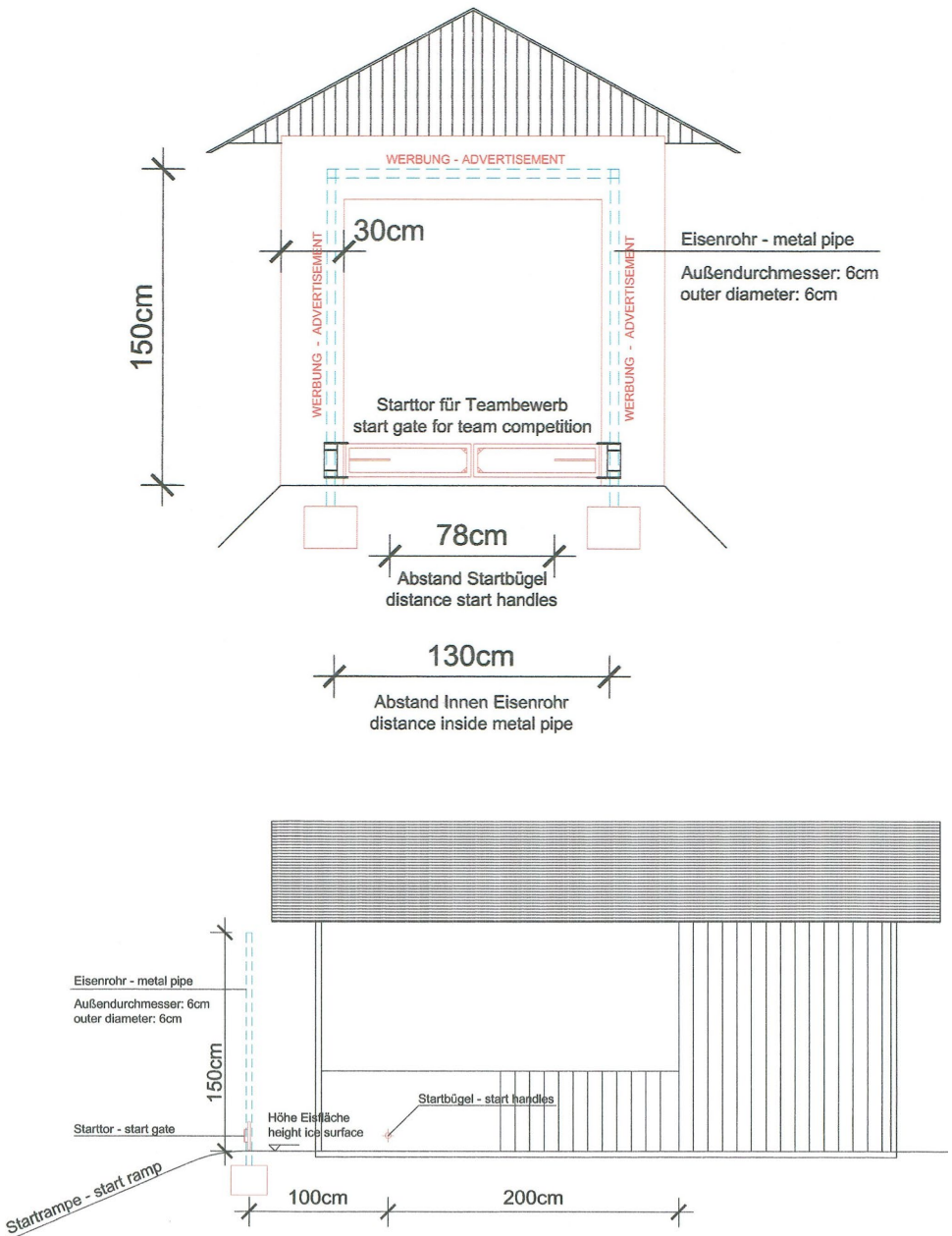

# Drawing 5

Start gates for parallel competition

